

Work happily



V1.2

naggura'swop

naggura.com

Our products



Spa



The Swop S3 HT SPA is an electrical 3-section table with a one-piece mattress, wooden structure, TwinLift armrest system and heating.

Wood, Metal or Pmma



Collections

Nordic
METAL

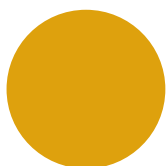

Yellow

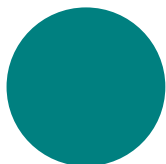

Blue

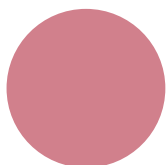

Pink

Foll
METAL

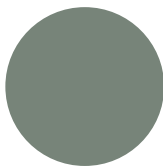

Ash

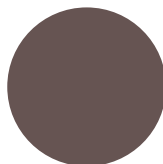

Clay

Iron
METAL

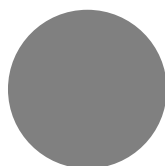

Inox

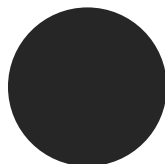

Black

Om
WOOD



Oak



Wenge

Techno
PMMA



Fluor



Fuxia



Ice

SWOP S3 HT SPA



Dimensions

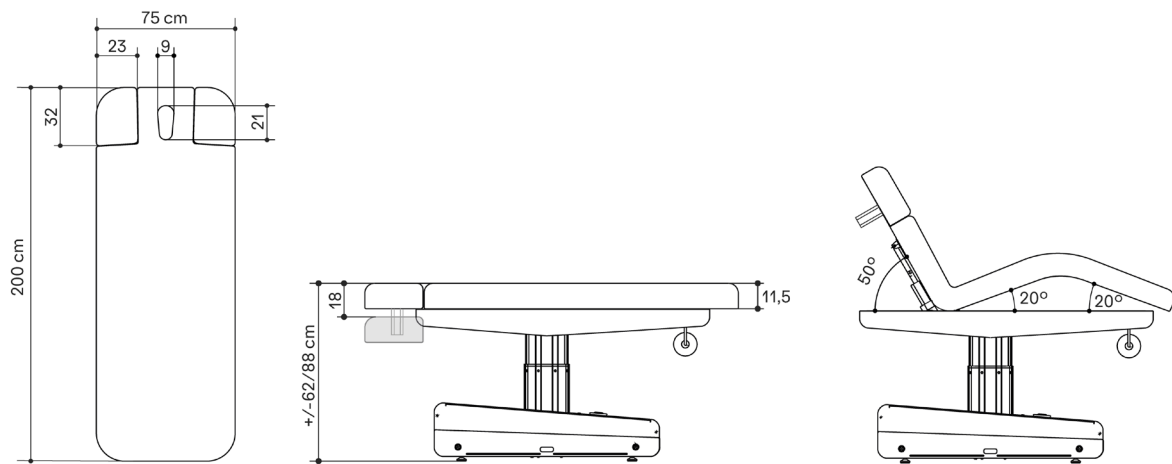

General specifications

MOTORS

3 engine (height, footrest, backrest)

DIMENSIONS (LENGTH X WIDTH)

200 x 75 cm

HEIGHT (MIN. AND MAX.)

62/88 cm

WEIGHT

110 kg

THICKNESS

11,5 cm (10 cm latex and 1,5 cm wood base)

DENSITY
30 kg/m³

LIFTING CAPACITY

175 kg

OPERATION

Hand controller (included)/
Foot controller (optional)

POWER SUPPLY

230 V - 50/60 Hz

MAX. INTENSITY

2 A

ELECTRIC MOTOR

6.000 N

FEATURES

TwinLift armrest system
Heating
Roll holder

CUSHION

Upholstery Seamless
round edges

Naggura Skin upholstery:
100% vinyl compound in
white.

Superior abrasion resis-
tance: >250.000 cycles.
Protection against germs
and UV rays.